



# Ergo Tools

## Pricing and Specification Guide

KEYBOARD SYSTEMS  
LAPTOP HOLDERS  
CPU HOLDERS  
DOCUMENT HOLDERS  
FOOT RESTS  
GLARE FILTERS  
INPUT DEVICES



# Table of Contents

Best-Selling Keyboard Systems .....	3
Build Your Keyboard System Product Code .....	4
Mechanism Options .....	5
Keyboard Platform Options .....	6
Mouse Platform Options .....	8
Palm Support Options .....	9
Track Options .....	9
Keyboard System Accessories .....	10
Ergonomic Accessories .....	11
Humanscale and the Environment .....	14
Terms & Conditions .....	15

## Other Humanscale price guides available in PDF format:



Seating



Lighting



Monitor Arms



Access Rail



Healthcare

For the most updated information on available Humanscale products, please visit:  
[www.humanscale.com](http://www.humanscale.com)

# Best-Selling Keyboard Systems

With advanced technology, award-winning designs and hundreds of options, Humanscale has remained the market leader in keyboard supports for 10 years running. We pioneered intuitive adjustability and eliminated knee obstruction. And these best-sellers remain several steps ahead of the pack.

**All keyboard systems are available to ship within 72 hours.**

## White 6G System

- Standard White 6GW Mechanism
- White 900 or 950 Platform
- White High Clip Mouse\* (8.5" or 10" Mousing Surface)
- Gray Gel Mouse Pad
- Gray Synthetic Leather Gel Palm Support

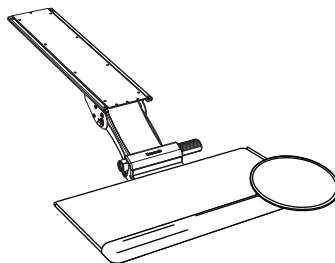

<b>Std 6GW/8.5"</b>	<b>6GW 900 90H G</b>	\$454
	<b>6GW 950 90H G</b>	\$454
<b>Std 6GW/10"</b>	<b>6GW 900 91H G</b>	\$454
	<b>6GW 950 91H G</b>	\$454

## Clip Mouse System

- 2G or 6G Mechanism
- Standard 900 Platform
- High Clip Mouse (8.5" or 10" Mousing Surface)
- Synthetic Leather Palm Support (Gel or Foam)
- Standard Black color scheme

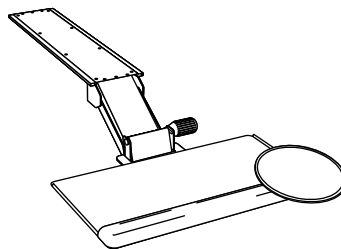

*Shown with 2G mechanism*

<b>8.5"/Gel</b>	<b>2G 900 90H G</b>	\$440
	<b>6G 900 90H G</b>	\$454
<b>10"/Gel</b>	<b>2G 900 91H G</b>	\$440
	<b>6G 900 91H G</b>	\$454
<b>8.5"/Foam</b>	<b>2G 900 90H F</b>	\$423
	<b>6G 900 90H F</b>	\$437
<b>10"/Foam</b>	<b>2G 900 91H F</b>	\$423
	<b>6G 900 91H F</b>	\$437

## Swivel Mouse System

- 2G or 6G Mechanism
- Standard 900 Platform
- 8" Swivel Mouse (Right or Dual)
- Synthetic Leather Palm Support (Gel or Foam)
- Standard Black color scheme

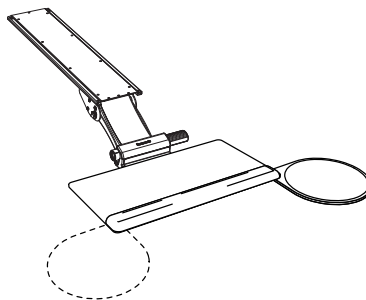

*Shown with 6G mechanism*

<b>Right/Gel</b>	<b>2G 900 11R G</b>	\$419
	<b>6G 900 11R G</b>	\$433
<b>Dual/Gel</b>	<b>2G 900 11D G</b>	\$467
	<b>6G 900 11D G</b>	\$481
<b>Right/Foam</b>	<b>2G 900 11R F</b>	\$402
	<b>6G 900 11R F</b>	\$416
<b>Dual/Foam</b>	<b>2G 900 11D F</b>	\$450
	<b>6G 900 11D F</b>	\$464

*\*Standard-height Clip Mouse also available for White 6G System.*

# Build Your Keyboard System Product Code

Choose from our many mechanisms, keyboard platforms, mouse platforms, palm supports and track lengths to configure your own customized keyboard system.

White mechanisms ship with White keyboard and mouse platform, Gray palm support and mouse pad.

Platinum mechanisms ship with Platinum keyboard and mouse platform, Gray palm support and mouse pad.

Black mechanisms ship with Black keyboard and mouse platform, Black palm support and mouse pad.

Keyboard System Product Code:

Mechanism	Keyboard Platform	Mouse Platform	Palm Support	Track (optional)
1	2	3	4	5
_____	_____	_____	_____	_____

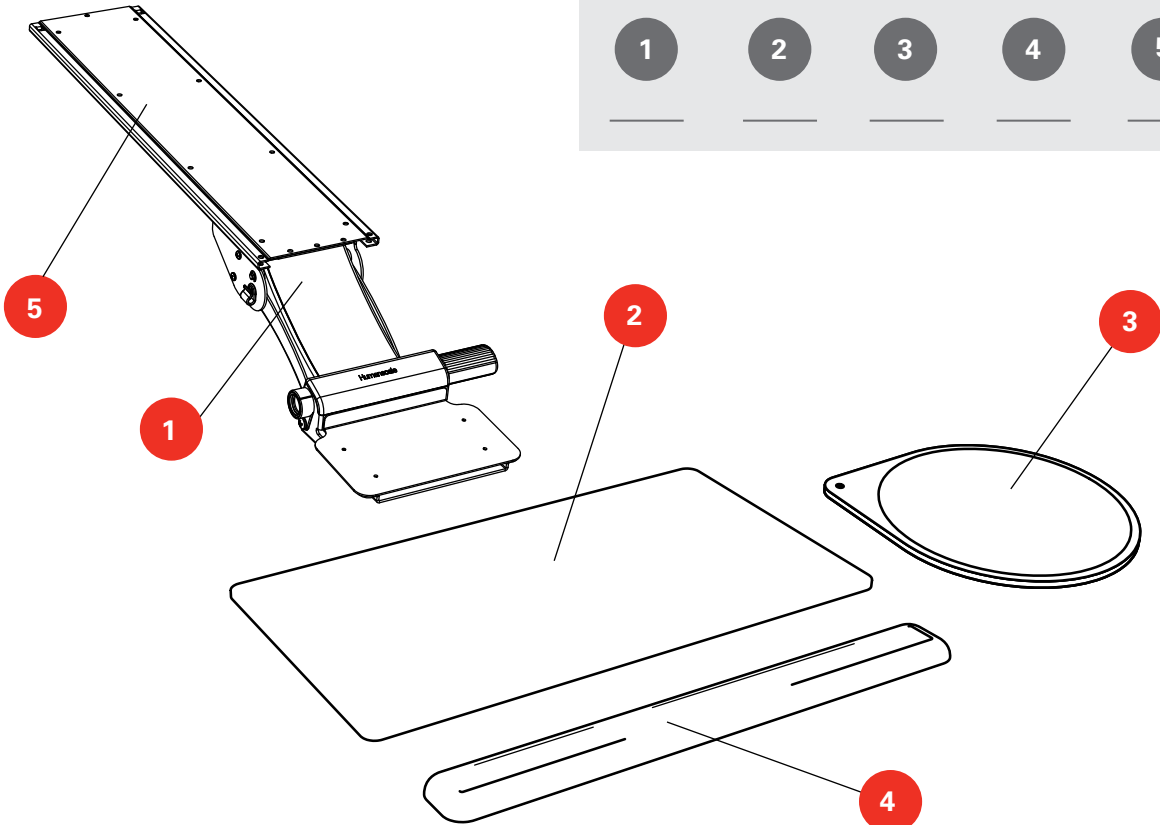

1

## Mechanism Options

All keyboard mechanisms, with the exception of the KM, offer 0° to -15° tilt for low-risk typing postures.  
Build-Your-Own configurations are available in Black only, unless otherwise noted.

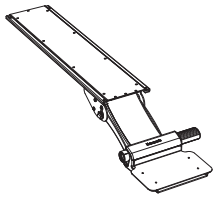

**6G** (Black), **6GW** (White) \$250  
Humanscale's most advanced keyboard mechanism to date, the 6G provides intuitive ergonomic adjustability and unmatched styling.  
7" height adjustment  
(1.75" above track to 5.25" below track)  
Comes standard with 21.625" track

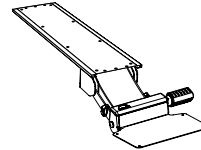

**5GSM** (Black), **5GSV** (Platinum) \$263  
The 5G Short Mechanism provides 5G functionality with a shorter arm for small workstations and tight spaces.  
4" height adjustment  
(0.5" above track to 3.5" below track)  
Comes standard with 18" track

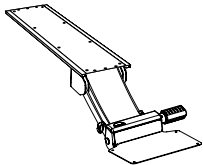

**5G** (Black), **5GV** (Platinum) \$263  
The world's best-selling keyboard mechanism, the 5G combines easy dial-a-tilt and height adjustability with the strongest arm on the market.  
6.25" height adjustment  
(1.25" above track to 5" below track)  
Comes standard with 21.625" track

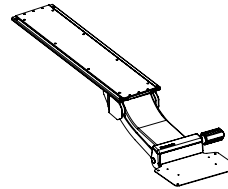

**5GAD** \$326  
The 5G Above Desk mechanism provides 5G functionality with a longer arm for use above the work surface.  
13.5" height adjustment  
(7.5" above track to 6" below track)  
Comes standard with 27" track

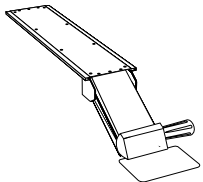

**4G** \$368  
The 4G represents revolutionary keyboard technology with simple dial-a-tilt keyboard angle adjustability.  
6.25" height adjustment  
(1.25" above track to 5" below track)  
Comes standard with 21.625" track

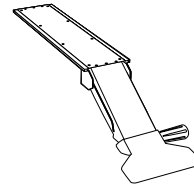

**4GAD** \$326  
The 4G Above Desk mechanism provides 4G functionality with a longer arm for use above the work surface.  
11.5" height adjustment  
(8.5" above track to 3" below track)  
Comes standard with 27" track

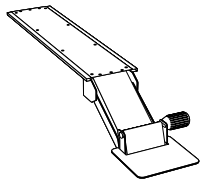

**2G** \$236  
The original standard bearer, the 2G offers independent height and tilt adjustment and unmatched stability.  
6.25" height adjustment  
(1.25" above track to 5" below track)  
Comes standard with 21.625" track

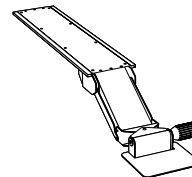

**DS** \$352  
The Double Swivel provides an additional pivot point for increased adjustability.  
80° swivel at platform  
6.25" height adjustment  
(1.25" above track to 5" below track)  
Comes standard with 25" track

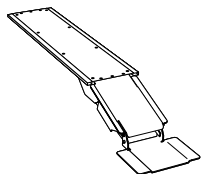

**KM** \$215  
The Standard Pre-Set Tilt Arm offers total knee clearance, knob-free adjustment and 0° tilt.  
6.25" height adjustment  
(1.25" above track to 5" below track)  
Comes standard with 21.625" track

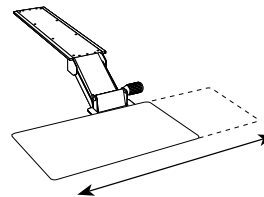

### Mechanism Accessory

**LS** \$84  
The Lateral Slider allows the platform to be adjusted left or right a total of 8" for optimal keyboard positioning. It can be ordered with any keyboard mechanism by indicating "LS" after the mechanism code (e.g., 6GLS or 6GWLS).

## 2 Keyboard Platform Options

All Build-Your-Own platforms are available in Black only, unless otherwise noted.

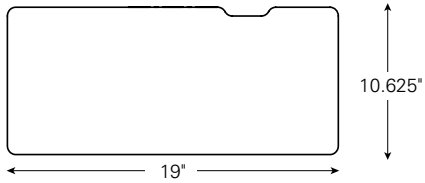

**900 Standard** \$97

Available in White with 6GW.  
Available in Platinum with 5GV or 5GSV.

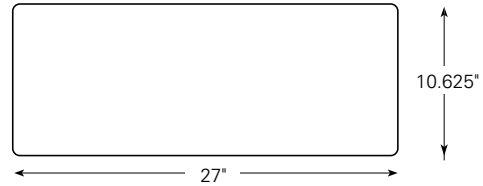

**500 Big** \$145

Comes with built-in mousing surface.  
Not available with other mouse platform options.  
Available in Platinum with 5GV or 5GSV.

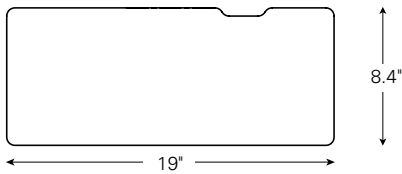

**950 Standard Compact** \$97

Available in White with 6GW.  
Available in Platinum with 5GV or 5GSV.

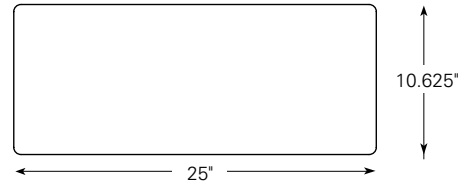

**550 Big Compact** \$145

Comes with built-in mousing surface.  
Not available with other mouse platform options.  
Available in Platinum with 5GV or 5GSV.

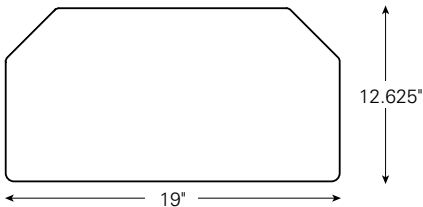

**700 Diagonal** \$97

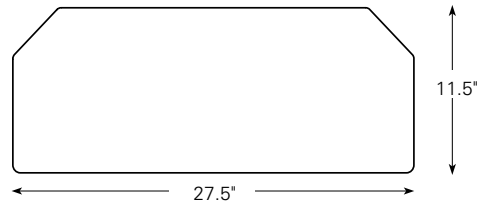

**400 Diagonal Big** \$145

Comes with built-in mousing surface.  
Not available with other mouse platform options.

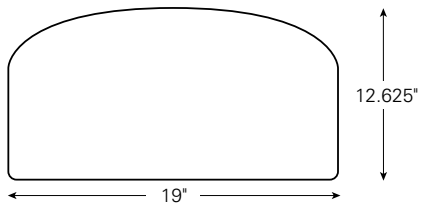

**800 Radiused** \$97

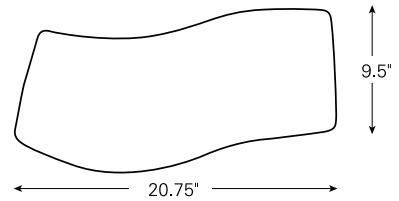

**300 Curved** \$97

*Not available with a palm support.*

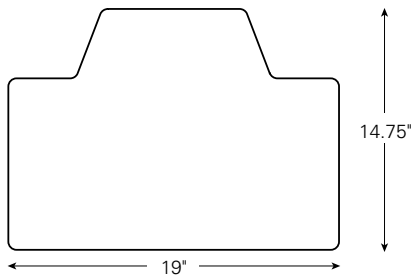

**600 Extender** \$118

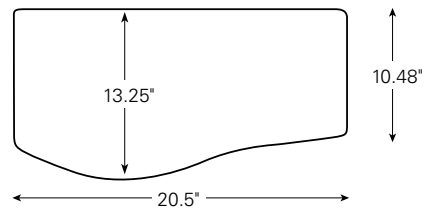

**100 Combo** \$97

### 3 Mouse Platform Options

All Build-Your-Own mouse platforms are available in Black only, unless otherwise noted.

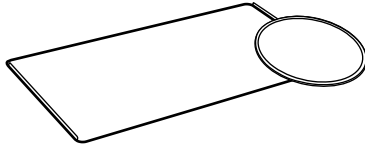

<b>90</b>	<b>8.5" Clip</b>	\$69
<b>90H</b>	<b>8.5" High Clip</b>	\$69

Available in White with 6GW.  
Available in Platinum with 5GV or 5GSV.

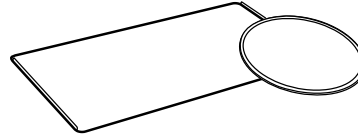

<b>91</b>	<b>10" Clip</b>	\$69
<b>91H</b>	<b>10" High Clip</b>	\$69

Available in White with 6GW.  
Available in Platinum with 5GV or 5GSV.

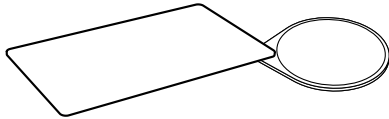

<b>11R</b>	<b>8" Swivel Right</b>	\$48
<b>11L</b>	<b>8" Swivel Left</b> <i>(not pictured)</i>	\$48
<b>11D</b>	<b>8" Swivel Dual</b> <i>(not pictured)</i>	\$96

Not available with 6GW, 5GV, or 5GSV.

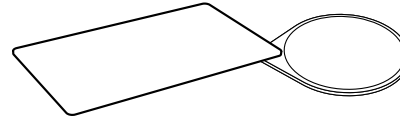

<b>12R</b>	<b>10" Swivel Right</b>	\$48
<b>12L</b>	<b>10" Swivel Left</b> <i>(not pictured)</i>	\$48
<b>12D</b>	<b>10" Swivel Dual</b> <i>(not pictured)</i>	\$96

Not available with 6GW, 5GV, or 5GSV.

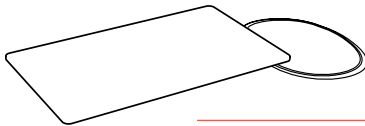

<b>81R</b>	<b>M² Right</b>	\$48
<b>81L</b>	<b>M² Left</b> <i>(not pictured)</i>	\$48
<b>81D</b>	<b>M² Dual</b> <i>(not pictured)</i>	\$96

Not available with 6GW, 5GV, or 5GSV.

4

## Palm Support Options

All Build-Your-Own palm supports are available in Black only, unless otherwise noted.

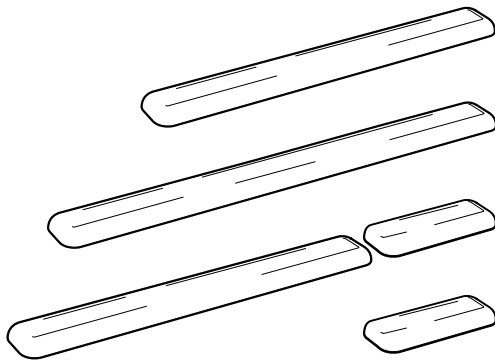

5

## Track Options

All keyboard systems ship with track lengths noted on page 5 unless a different track length is specified. Please use these codes to order a specific track for your system.

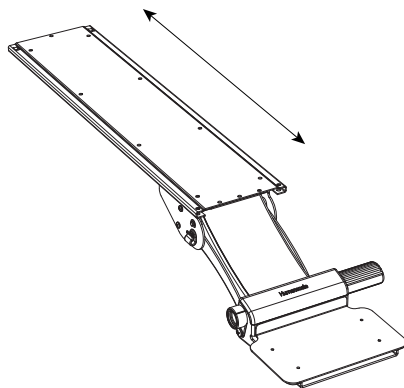

<b>F</b>	19" Foam with synthetic leather cover	\$21
<b>G</b>	19" Gel with Black or Gray synthetic leather cover	\$38
<b>F20</b>	20" Foam with synthetic leather cover	\$21
<b>G20</b>	20" Gel with synthetic leather cover	\$38
<b>F25</b>	25" Foam with synthetic leather cover	\$27
<b>G25</b>	25" Gel with synthetic leather cover	\$45
	<i>For 550 boards only</i>	
<b>F27</b>	27" Foam with synthetic leather cover	\$27
<b>G27</b>	27" Gel with Lycra knit cover	\$43
	<i>For 400 and 500 boards only</i>	
<b>FMP</b>	20" and 7" Foam with synthetic leather cover	\$33
<b>GMP</b>	20" and 7" Gel with synthetic leather cover	\$53
	<i>For 400 and 500 boards only</i>	
<b>MP7F</b>	7" Foam with synthetic leather cover	\$13
<b>MP7G</b>	7" Gel with synthetic leather cover	\$17
<b>27</b>	27" track	N/C
<b>25</b>	25" track	N/C
<b>22</b>	Standard 21.625" track	N/C
<b>18</b>	18" track	N/C
<b>16</b>	16" track	N/C
<b>14</b>	14" track	N/C
<b>11</b>	11" track	N/C

### Replacement Tracks with Hardware Pack *(if ordering without mechanism)*

<b>RT27</b>	27" track	\$59
<b>RT25</b>	25" track	\$54
<b>RT22</b>	Standard 21.625" track	\$43
<b>RT18</b>	18" track	\$43
<b>RT16</b>	16" track	\$43
<b>RT14</b>	14" track	\$43
<b>RT11</b>	11" track	\$43

# Keyboard System Accessories

## Mouse Pads



**HSMP12TIPS** \$5

**8" Ergo Tips Mouse Pad**

For 8" – 8.5" mouse platforms

**HSMP12TIPS10** \$6

**9" Ergo Tips Mouse Pad**

For 10" mouse platforms

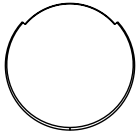

**CMPGEL8** \$26

**8.5" Gel Mouse Pad**

For 90 or 90H Clip Mouse

**CMPGEL** \$26

**10" Gel Mouse Pad**

For 91 or 91H Clip Mouse

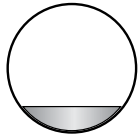

**MPGEL8** \$21

**8.5" Gel Mouse Pad**

**MPGEL10** \$26

**10" Gel Mouse Pad**

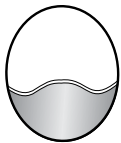

**GPSMP** \$37

Desktop Mouse Pad with Gel Palm

## Palm Support



**MM10** \$16

Mouse Mate



**GPS** \$43

Desktop Gel Palm Support

## Corner Sleeves

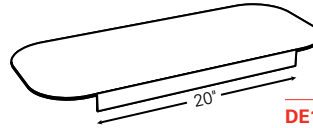

**DE100** \$128

29.5" x 12.188"

Fits desks 1" to 1.5" thick

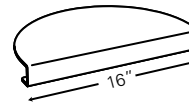

**DE200/DE250** \$81

16" diameter

DE200 fits desks 1" to 1.5" thick

DE250 fits desks 1.5" to 2.5" thick

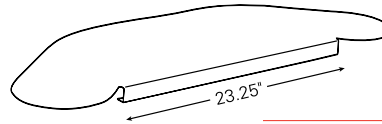

**DE400/DE450** \$209

38.5" x 13.75"

DE400 fits desks 1" to 1.5" thick

DE450 fits desks 1.5" to 2.5" thick

## Ergonomic Accessories

### Input Device



**Switch Mouse**

**SMUSB** \$120

Switch Mouse with USB connector,  
optical sensor and navigation dish

# Ergonomic Accessories

## Laptop Holders

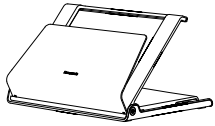

### Notebook Manager

**L6** \$150

Maximum Dimensions:  
13.5" W x 10.9" D x 10.1" H  
7.3" height adjustability

*(Accommodates notebook computers at least 10" wide and 6" deep, and up to 1.5" thick)*



### Removable USB Hub

**L6USB** \$30

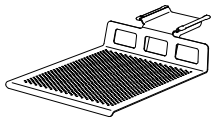

### Tech Tray

**TT** \$99

12" W x 14" D

*Comes standard with 16" track. Sits 3.5" below track.*



### Keyed Security Lock

**TT1** \$30

## Foot Rests

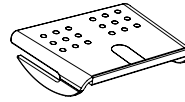

### Rocking Foot Machine

**FM500C** (Cherry) \$152

**FM500K** (Black) \$152

12.25" D x 16.75" W x 4.5" H



### Foot Machine with Massage Balls

**FM300B** (Natural) \$180

**FM300BDC** (Dark Cherry) \$180

11.875" D x 16" W  
Height Range: 3.75" to 6.75"

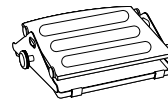

### Foot Machine

**FM300** (Natural) \$135

11.875" D x 16" W  
Height Range: 3.75" to 6.75"



### Tilting Foot Rest

**FM100** (Natural) \$125

11.75" D x 19" W x 3.375" H

## Cable Management



### NeatLinks – Small 17"

**NL17SB** (Black) \$19

**NL17SG** (Gray) \$19

Small 2.6" Diameter, 17" Length

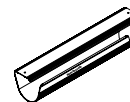

### NeatLinks – Large 17"

**NL17LB** (Black) \$21

**NL17LG** (Gray) \$21

Large 3.6" Diameter, 17" Length

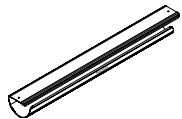

### NeatLinks – Small 24"

**NL24SB** (Black) \$21

**NL24SG** (Gray) \$21

Small 2.6" Diameter, 24" Length



### NeatLinks – Large 24"

**NL24LB** (Black) \$23

**NL24LG** (Gray) \$23

Large 3.6" Diameter, 24" Length

# Ergonomic Accessories

## CPU Holders

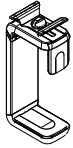

**CPU600** (Black) \$168  
**CPU600W** (White) \$168

Fits CPUs 3.5" to 9"  
wide by 12" to 20" high  
Max CPU Weight: 50 lbs.

Installed Dimensions:  
7" or CPU Width + 1.7" (whichever is  
greater), CPU Height + 3.6"

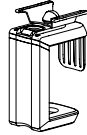

**CPU200** (Black) \$150  
**CPU200W** (White) \$150

Fits CPUs 1" to 5" wide by 12" high  
Max CPU Weight: 15 lbs.

Installed Dimensions:  
6.7" Width, CPU Height + 3.8" (plus ad-  
ditional 1.2" with spacer option)

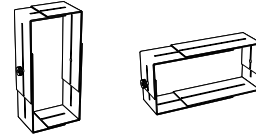

**CPU450** \$131

Fits CPUs 4" to 8" by 11.5" to 20"  
Max CPU Weight: 50 lbs.

Installed Dimensions:  
CPU Width + 2.5"; CPU Height + 3.75"

**CPU450STK** \$33

Swivel Track Upgrade Kit

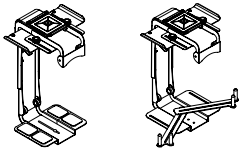

**CPU555** \$164

Fits CPUs 3" to 9.5" wide  
by 12" to 22" high  
Max CPU Weight: 70 lbs.

Installed Dimensions:  
CPU Width + 3.5"; CPU Height + 4.5"

**CPU555SEC** \$196

With Security System

**CPU555STOOL** \$27

Replacement Tool Kit for CPU555SEC  
(comes standard with CPU555SEC)

**CPU555SECKIT** \$50

Retrofit Security Kit for CPU555  
(comes standard with CPU555SEC)

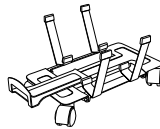

### CPU Dolly

**CPUDLY** \$153

Fits CPUs 3.25" to 9" wide

Installed Dimensions:  
CPU Height + 3.75"

**CPUDLYPLT** \$164

With Platform  
For CPUs 1.5" to 9" wide

**CPUPLATFORM** \$17

CPU Dolly Retrofit Platform

**CPUDLYH** \$38

Telescoping Pull Handle

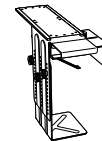

**CPU300** \$142

Fits CPUs 3.25" to 9" wide by 10.5" to 18" high  
Max CPU Weight: 70 lbs.

Installed Dimensions:  
CPU Width + 1.5"; CPU Height + 3"

## Quick Track

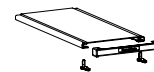

### Quick Track and Bracket

**16QT** 16" Quick Track \$56  
**22QT** 22" Quick Track \$56

Easily removable (without tools) front bracket  
makes swap-outs a snap.

To order, simply add "16QT or 22QT" to end of  
product code (e.g., CPU55516QT).

Comes standard with CPU600.

## Glare Filters

### Flat Panel Filters

with Tempered Glass and  
95% Transmission (5% Tint)



**NOTE:**

Filter fits size of monitor indicated by number in code.  
For example, FP15 fits 15" monitors.

#### Standard

<b>FP15</b>	14.25" W x 10.875" H	\$126
<b>FP17</b>	14.625" W x 12.75" H	\$218
<b>FP19</b>	15.75" W x 12.375" H	\$246
<b>FP20</b>	17.125" W x 13" H	\$263
<b>FP21</b>	18.125" W x 13.75" H	\$273

#### Privacy

<b>FP15PF</b>	13.125" W x 10" H	\$235
<b>FP17PF</b>	15" W x 11.5" H	\$290
<b>FP19PF</b>	15.75" W x 12.375" H	\$322
<b>FP20PF</b>	17.125" W x 13" H	\$333
<b>FP21PF</b>	18.125" W x 13.75" H	\$350

## In-Line Document Holders

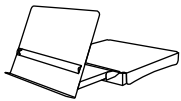

### Copy Drawer

<b>CH3000</b> (Putty)	\$153
<b>CH3000B</b> (Black)*	\$153
15" D x 15.5" W x 3" H	



### Copy Stand

<b>CH1000</b> (Putty)	\$126
<b>CH1000B</b> (Black)*	\$126
12" D x 14" W x 3" H	
<i>For use with CRTs</i>	



### Copy Stand Basic

<b>CH900</b> (Putty)	\$110
<b>CH900B</b> (Black)*	\$110
11" D x 14" W x 3" H	
<i>For use with flat panel monitors</i>	

\* Black may require up to an 8–10 week lead time. See your Humanscale sales representative for more information.

## Security Lock

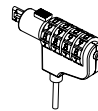

### Security Lock

<b>SECLOCK</b>	\$30
For CPUs, laptops, flat panels, etc.	
Combination lock with 3' cord.	
<i>Fits all units with standard security keyhole</i>	



### Keyed Security Lock

<b>TT1</b>	\$30
For CPUs, laptops, flat panels, etc.	
Keyed lock with 2' cord.	
<i>Fits all units with standard security keyhole</i>	

## Humanscale and the Environment

RECYCLED MATERIALS			
Product	Recycled Content	Recyclable Content	LEED Recycled Content Post-Consumer +1/2 Pre-Consumer
Diffrient Task and Work Light with Base	90% recycled (63% Post-Consumer, 27% Pre-Consumer)	90% recyclable	77%
Diffrient Technology Light	38% recycled (13% Post-Consumer, 25% Pre-Consumer)	98% recyclable	26%
Element Light, Element 790	81% recycled (55% Post-Consumer, 26% Pre-Consumer)	99% recyclable	68%
Tolomeo Light	77% recycled (40% Post-Consumer, 27% Pre-Consumer)	87% recyclable	52%
Freedom Chair	62% recycled (43% Post-Consumer, 19% Pre-Consumer)	90% recyclable	53%
Freedom Saddle/ Pony Saddle	59% recycled (41% Post-Consumer, 18% Pre-Consumer)	90% recyclable	50%
Liberty Chair	54% recycled (32% Post-Consumer, 22% Pre-Consumer)	93% recyclable	43%
Liberty Side Chair	85% recycled (49% Post-Consumer, 36% Pre-Consumer)	93% recyclable	67%
Cinto chair	26% recycled (15% Post-Consumer, 11% Pre-Consumer)	100% recyclable	21%
Diffrient World Chair	34% recycled (10% Post-Consumer, 24% Pre-Consumer)	97% recyclable	22%
M2 Monitor Arm	52% recycled (46% Post-Consumer, 6% Pre-Consumer)	99% recyclable	49%
M8 Monitor Arm	62% recycled (43% Post-Consumer, 19% Pre-Consumer)	99% recyclable	53%
M7 Monitor Arm	90% recycled (63% Post-Consumer, 27% Pre-Consumer)	100% recyclable	77%
M4 Monitor Arm	67% recycled (47% Post-Consumer, 20% Pre-Consumer)	100% recyclable	57%
Paramount	48% recycled (33% Post-Consumer, 15% Pre-Consumer)	99% recyclable	41%
Access Rail	98% recycled (70% Post-Consumer, 28% Pre-Consumer)	100% recyclable	84%
Keyboard Systems	25% recycled (15% Post-Consumer, 10% Pre-Consumer)	80% recyclable	20%
CPU600, CPU200	51% recycled (34% Post-Consumer, 17% Pre-Consumer)	99% recyclable	43%
CPU555, CPU450, CPU300, CPU Dolly	30% recycled (21% Post-Consumer, 9% Pre-Consumer)	90% recyclable	26%
NeatLinks	50% recycled (50% Post-Consumer, 0% Pre-Consumer)	100% recyclable	50%
L6	30% recycled (23% Post-Consumer, 7% Pre-Consumer)	90% recyclable	27%

# Humanscale Terms and Conditions

*THE FOLLOWING TERMS & CONDITIONS APPLY TO ALL HUMANSCALE PRODUCTS.*

## TERMS OF PAYMENT

Upon approved credit, terms of payment are net 30 from date of shipment. Deposits may be required for large or custom orders. The processing of orders and/or shipment of orders placed may be delayed if the deposit is not received with the order or if customer's account is in "Past Due" status.

## CREDIT POLICY

All customers of Humanscale must complete a credit application, with current information, which must be signed by an owner or officer. A line of credit may be set by our Credit Department, however the basis for the line of credit may be changed or cancelled at our discretion and advance payment may be required. Any unpaid balance, upon which payments are not made according to the terms governing the sale, will be considered "Past Due" and will increase by a maximum of 2% per month, without forfeit of Humanscale's right to payment.

Any customer who has failed to pay for goods delivered or services rendered in a timely manner shall be liable for all fees, expenses, disbursements, and charges (including all legal costs) incurred by Humanscale in collecting monies owed, as well as interest (at 24% per annum).

## PURCHASE ORDERS

Purchase orders must include the following: "Bill To" and "Ship To" information—Company Name (Ship To company may be end user or installation company), Address, Telephone, Fax, Contact Person; End User Company Name; Requested Ship Date; Purchase Order Number; Special Delivery, Shipping and Packing Instructions (if applicable); Proper Discount Off Current List Price, Product Quantities and Full Model Numbers; and Total (List/Net).

## ORDER CHANGES & CANCELLATIONS

All changes to or cancellations of orders placed with Humanscale must be in writing and sent to Customer Service. Orders may be changed or cancelled without penalty if Humanscale is notified at least two (2) weeks before the scheduled ship date for standard orders (under 250 units), or at least three (3) weeks before the scheduled ship date for large orders (250 units or more). Order changes or cancellations made less than two (2) weeks before the scheduled ship date for standard orders or less than three (3) weeks before the scheduled ship date for large orders will incur a minimum change/cancellation fee of 10% of net. Irrespective of when notified, changes or cancellations are not binding upon Humanscale until Humanscale issues a written acknowledgment of the change or cancellation. Order changes are defined as the deletion of line items; changes in style, color, quantity or requested ship date; or ship-to address changes. Order changes that result in a quantity reduction may be subject to an additional small order fee or adjustment in pricing. Under no circumstances will changes or cancellations be accepted on any custom fabric, special order or custom product orders.

## TAXES

Humanscale list prices do not include sales tax. Customer is responsible to remit all such tax. Humanscale requires a State Resale/Exemption Certification to be on file at its main office. Sales made without said Certificate will be charged the appropriate sales tax.

## PRICES

All discounts and list prices are subject to change without notice. Prices are those in effect at the time of order entry. If the requested shipment date is more than 90 days after the order date, Humanscale reserves the right to price said order based on the published list price as of the shipment date.

## SMALL ORDER FEE

A 3% small order fee applies to all invoiceable orders of \$1,500 net or less, including billable replacement parts, regardless of product category.

## SHIPPING AND DELIVERY

All Humanscale orders are acknowledged with a promise date (scheduled ship date) based on the product with the longest lead time. Large orders may increase standard lead times. Standard shipping charges will be billed to customer. Custom platform orders require 4 to 6 weeks.

Seating orders, unless otherwise specified, will ship 4 to 6 weeks from the date of order. Unless otherwise contractually specified, Diffrient World, Freedom and Liberty chairs will ship with the base and frame disassembled. Chairs can be easily assembled in seconds without use of tools. Blanket-wrapped shipping is available for full truckloads of 200 or more Diffrient World, Freedom or Liberty Task and Conference chairs. Consult your Humanscale representative for blanket-wrapped shipping requirement for Cinto and the Liberty Side chair.

**Ship Sets:** All products ordered on a single purchase order will be delivered together in a single ship set. To break a ship set, customers must indicate "Ship as Available" on the purchase order. Upon request, customer accounts may be defaulted to ship all orders on an as-available basis.

**Shipping Instructions:** Humanscale will attempt to accommodate basic shipping instructions, such as "call ahead" or "deliver before 12:00 p.m.," if clearly identified on the purchase order as "Shipping Instructions."

**Packing Instructions:** Humanscale will attempt to accommodate basic packing instructions for internal delivery of specific items on an order, such as "Deliver to Joe Smith" or "Deliver to cube #218," if clearly identified on the purchase order as "Packing Instructions."

## DELIVERY SHORTAGES

Product shortages must be noted at the time of delivery and reported to the carrier for correction. Claims against Humanscale for shortages, errors, etc., must be made in writing and within three (3) days of the date of delivery or customer waives its right to make such a claim.

## FREIGHT CLAIMS

Humanscale will file all F.O.B. destination claims. In order to receive credit, customer agrees to cooperate and assist in the procedures set out by the carrier and Humanscale.

## EXTERNAL DAMAGE

If the shipping container shows any external damage, customer is instructed to refuse the product at time of delivery. If it is a multiple piece shipment, customer may refuse only the damaged items. Humanscale will not issue full credit for returned product unless customer takes the following action steps:

**15**

1. Note damage on the delivery receipt at time of delivery.
2. Refuse product at time of delivery.
3. Contact Humanscale Customer Service within 24 hours of the attempted delivery and advise them of the damage.
4. Enter a chargeable replacement order; credit will be issued after the disposition of damaged product is determined.

### CONCEALED DAMAGE/LOSS

If customer determines that there is internal damage not visible at time of delivery, customer will retain all packaging materials and take the following action steps within fifteen (15) calendar days from the date of delivery:

1. Request inspection by calling local freight carrier to report damage.
2. Retain merchandise in the original box.
3. Call your Humanscale Customer Service agent to provide order and product information.
4. Get a copy of the inspection report from carrier.
5. Enter a chargeable replacement order; credit will be issued after the disposition of damaged product is determined.

### STORAGE

If a customer is unable to accept a scheduled product delivery, Humanscale, if notified in writing after product assembly and prior to the scheduled ship date, will store the product at customer's expense. Humanscale shall invoice customer for the product and monthly Storage Fees.

Storage Fees will be 1% of the net order value per month or actual storage costs—which ever is greater. Storage Fees are calculated with a one-month minimum and will not be pro-rated. If customer is unable to accept a scheduled product upon delivery, customer shall be responsible for placing the product in storage and bears the risk of loss. However, payment of the balance due is per Humanscale's Terms of Payment.

### RETURN AUTHORIZATIONS & REFUSALS

All returned and non-damaged refused orders are subject to a five percent (5%) restocking fee. Seating and special order returns will not be accepted. Customer must request a Return Authorization through the Humanscale Customer Service Department within 45 days of product receipt to return any product. If Humanscale agrees to restock the product, customer must return it freight prepaid to Humanscale, F.O.B., to the original shipping point or as otherwise instructed by Humanscale Customer Service. If product is returned without a Return Authorization, Humanscale will notify customer of the unauthorized return and customer must provide instructions for its disposition within one week thereafter. Failure of customer to respond within one week will result in Humanscale's right to dispose of the product with no credit. Return Authorizations expire sixty (60) days after the date of issue. If the returned product is not in resalable condition, customer will not receive credit for the return. Customer must promptly provide a purchase order or other acceptance of fees/credit reduction as required.

### WARRANTY

THE FOLLOWING WARRANTY IS IN LIEU OF ALL OTHER WARRANTIES EXPRESS OR IMPLIED, INCLUDING, BUT NOT LIMITED TO, THE IMPLIED WARRANTY OF MERCHANTABILITY AND FITNESS FOR A PARTICULAR PURPOSE AND ALL OTHER WARRANTIES ARISING FROM COURSE OF DEALING OR USAGE OF TRADE.

Humanscale offers the following warranties on its products:

PRODUCT	WARRANTY
Customer's Own Material (COM, COL)	No Warranty
CFL Light Bulbs	1 Year, Single-Shift Warranty
Switch Mouse	1 Year, 24/7 Warranty
Artemide Tolomeo Light	2 Years, 24/7 Warranty
Diffrient Light	5 Years, 24/7 Warranty
Fabric/Cushions/Arm Pads	5 Years, Single-Shift Warranty
Element Light, Including Light Source	10 Years, 24/7 Warranty
M4, M7 & M8 Monitor Arms with Gas Cylinder Components	10 Years, 24/7 Warranty
All seating and other products detailed in a current Humanscale Price Guide, unless otherwise specified	15 Years, 24/7 Warranty
All other products NOT detailed in a current Humanscale Price Guide	Varies; consult your Humanscale representative for details

This Warranty is applicable to the initial purchaser only and is non-transferable. If products are procured through authorized Humanscale Dealerships, the end-user customer must be registered with Humanscale for the warranty to be in effect. Humanscale warrants that, at the time of customer's receipt, the product will be in good working order and will be free from defects in material and workmanship. This Warranty does not apply to normal wear and tear or damage caused by accident, neglect, misuse or improper installation or operation. Humanscale will not be responsible for damage due to service, maintenance, modifications or tampering by anyone other than a Humanscale authorized representative. In the event a product is defective and Humanscale receives written notice of the defect within the Warranty period, Humanscale, at its option, will either repair or replace the defective product. This Warranty does not cover damage caused by a carrier or transportation of the product from one location to another, or alterations made by owner.

### LIMITATION OF LIABILITY

Purchaser's remedies set forth herein are exclusive and the liability of Humanscale with respect to the breach of this agreement or any contract entered into between the parties pursuant hereto shall not exceed the price of the product or part on which such liability is based. In no event will Humanscale be liable to purchasers for any special, collateral, incidental or consequential damages however caused, whether by Humanscale's negligence or otherwise.

The remedies provided above are the purchaser's sole remedies for any failure of Humanscale to comply with its obligations regarding the workmanship of its products. Correction of any nonconformity in the manner and for the period of time provided shall constitute complete fulfillment of all liabilities of Humanscale, with respect to or arising out of the product furnished hereunder.



# Ergo Tools Pricing and Specification Guide

**Price Guide - U.S.** Prices effective November 2010



#### **Customer Service**

10 Inverness Drive East  
Suite 100  
Englewood, CO 80112  
800 400 0625  
303 858 9912  
303 858 9916 fax  
info@humanscale.com

#### **U.S. Headquarters**

11 East 26th Street  
8th Floor  
New York, NY 10010  
212 725 4749  
212 725 7545 fax

#### **International Headquarters**

13 Northburgh Street  
London  
EC1V 0JP  
United Kingdom  
+44 207 566 7990  
+44 207 566 7991 fax  
info@humanscale.co.uk

**[www.humanscale.com](http://www.humanscale.com)**