



Lighting

Pricing and Specification Guide



Humanscale designs and manufactures products for the workplace that directly impact the user's health and comfort.

Since our founding in 1983, we have held the belief that design based on functionality and ease of use results in honest and enduring forms.

Other Humanscale price guides available in PDF format:



Seating



Monitor Arms



Ergo Tools



Access Rail



Healthcare

For the most updated information on available Humanscale products, please visit:
www.humanscale.com

Table of Contents

PRICE LIST

Build Your Element Light Product Code.....	4
Build Your Artemide Tolomeo Light Product Code	6
Build Your Diffrient Light Product Code	8
Build Your Diffrient Technology Light Product Code.....	10
Lighting Accessories.....	12
Humanscale and the Environment	13
Terms & Conditions	14

Build Your Element Light Product Code

Element Light

To create the product code for your Element Light, simply choose your preferred style, plug, mount and color, and combine the respective codes for each.

Element Light Product Code:

Style	Plug	Mount	Color
1	2	3	4
_____	_____	_____	_____

1 Style

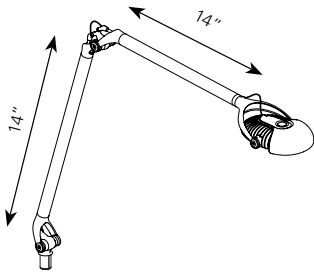

EL \$474
Element Classic: 7-Watt
MCX LED Light

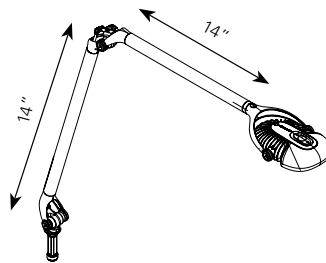

ED \$539
Element 790: 7-Watt Hi-Output
MCX LED with Dimmer

2 Plug



E N/C
North America

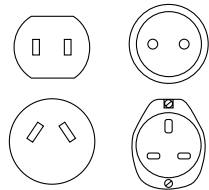

U Add \$5
Universal
(4 interchangeable plugs)

3 Mount

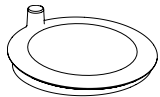

B Add \$60
Element Desktop Base
8" diameter

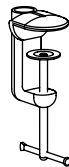

C N/C
Clamp
For grommet or edge mount. Fits
surfaces up to 2" thick and grommet
holes 2" or more in diameter.

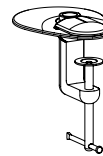

G Add \$12
Clamp with Grommet Cover
For grommet holes 2" – 3.25" in
diameter.

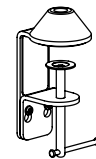

K Add \$18
2-Piece Clamp
Requires minimum 1/4" clearance
between desk and wall or panel.



3 Mount, cont.



Panel Mount Add \$30

- PC** Allsteel Concensys
- P2** Allsteel Terrace 2.6 & 3.4, Align
- PH** Haworth Places, Unigroup
- PM** Haworth Premise
- PA** Herman Miller Action Office
- PR** Herman Miller Resolve
- P9** Steelcase 9000
- PB** Teknion Boulevard
- PI** Teknion IE
- PL** Teknion Leverage, Transit

*Not compatible with corner mount applications.
For other panel systems, see your Humanscale representative.*

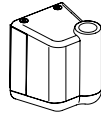

U Add \$30

Universal Panel Mount
Adjusts to fit most panels that use vertical slotted rails for mounting accessories. Not compatible with corner applications.

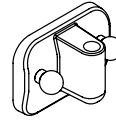

S N/C

Universal Slatwall
Adjusts to fit most standard slatwalls.



W N/C

Wall
Screws into vertical surface.



A N/C
Humanscale Access Rail



D N/C

Direct
Screws into horizontal surface.

NM N/C
No Mount

4 Color

S
Silver

W
White

B
Black
ONLY available with ED style

Element Light Replacement Parts *(if purchased separately)*

ELEMENT LIGHT MOUNTS

Element Desktop Base	ELBS (silver), ELBW (white) ELBB (black)	\$102
Access Rail	DLAS (silver), DLAB (black)	\$42
Clamp <i>For grommet or edge mount</i>	DLCS (silver), DLCB (black)	\$42
2-Piece Clamp <i>For edge mount</i>	DLKS (silver), ELKW (white) DLKB (black)	\$60
Direct	DLDS (silver), ELDW (white) DLDB (black)	\$42
Universal Slatwall	DLSS (silver)	\$42
Wall	DLWS (silver)	\$42
Universal Panel Mount	DLUS (silver), DLUB (black) ELUW (white)	\$72
Panel Mount	DL 1 1 2	\$72
	<small>(1): Panel System Code, (2): Color (B or S)</small>	
Grommet Cover	DLGC (black)	\$12
<i>For use with Clamp Mount C</i>		
Replacement LED Head Kit	ELHEADKITS	\$120
North American Plug Set	ELPLUGE	\$42
Universal Plug Set	ELPLUGU	\$60

Note: All Silver lights ship with Silver mounts.

All Black lights ship with Black mounts.

All White lights ship with Silver mounts, except Desktop Base (B), Two-Piece Clamp (K), and Direct (D) which ship White.



Build Your Artemide Tolomeo Light Product Code

Tolomeo Light

To create the product code for your Tolomeo Light, simply choose your preferred style, mount, color, and lamp and combine the respective codes for each.

Special dealer discounting for Tolomeo product line. Consult your Humanscale rep.

Tolomeo Light Product Code:

Style	Mount	Color	Lamp
1	2	3	4
_____	_____	_____	_____

1 Style

TOLOMEO LED LIGHT (TL SERIES)

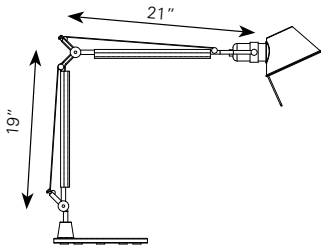

TLC \$522
10-Watt Tolomeo Classic LED Light

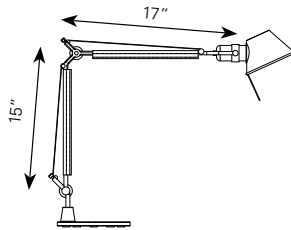

TLM \$498
10-Watt Tolomeo Mini LED Light

TOLOMEO CFL LIGHT (TT SERIES)

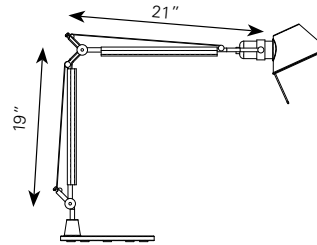

TTC \$360
Tolomeo Classic CFL Light

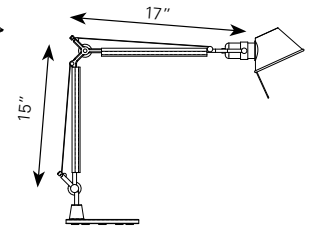

TTM \$342
Tolomeo Mini CFL Light

2 Mount

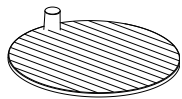

B Add \$192
Desktop Base for Classic
9" diameter

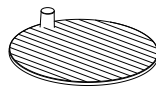

B Add \$180
Desktop Base for Mini
8" diameter



C Add \$66
Clamp

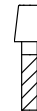

V Add \$48
In-Set Pivot
For mounting into horizontal surfaces.
Requires a hole 0.65" in diameter



2 Mount, cont.

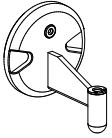

W Add \$66
Wall Surface

N N/C
No Mount

3 Color

S
Silver

4 Lamp

TOLOMEO 10-WATT LED LIGHT INCLUDED (TL SERIES)

— Standard LED N/C

Tolomeo Light Replacement Parts

(if purchased separately)

TOLOMEO LIGHT MOUNTS (TL & TT SERIES)

Desktop Base for Classic, 9"	TABCS (silver)	\$264
Desktop Base for Mini, 8"	TABMS (silver)	\$252
Clamp	TACS (silver)	\$138
In-Set Pivot	TAVS (silver)	\$120
Wall	TAWS (silver)	\$138

TOLOMEO CFL LIGHT ACCESSORIES (TT SERIES)

Lamp 18W, 3500K	DLCFL1	\$10
Lamp 23W, 3500K	DLCFL2	\$10
Lamp 13W, 3500K	DLCFL3	\$10
Lamp 9W, 3500K	DLCFL4	\$10
Lamp 18W, 2700K	DLCFL6	\$10
Lamp 18W, 5500K, Full spectrum	DLCFL7	\$36

TOLOMEO CFL LIGHT (TT SERIES)

1	18W, 3500K (standard)	Add \$6
2	23W, 3500K	Add \$6
3	13W, 3500K	Add \$6
4	9W, 3500K	Add \$6
6	18W, 2700K	Add \$6
7	18W, 5500K, Full Spectrum	Add \$24
0	No Bulb	N/C



Build Your Different Light Product Code

Diffrient Task Light II and Work Light II

To create the product code for your Diffrient Light, simply choose your preferred style, mount, color and lamp, and combine the respective codes for each.

Diffrient Task Light II and Work Light II Product Code:

Style	Mount	Color	Lamp
1	2	3	4
_____	_____	_____	_____

1 Style

DIFFRIENT TASK LIGHT II (DA SERIES)

Compatible with GU24 2-pin compact fluorescent bulbs.

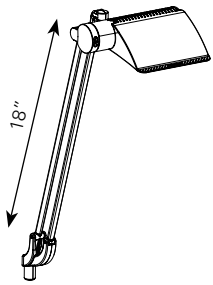

DA1E \$348
Single Arm with Task Shade

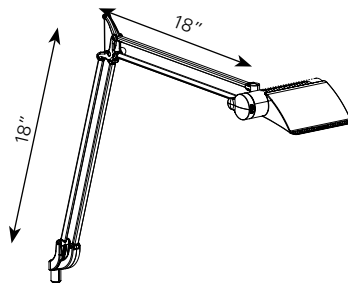

DA2E \$386
Double Arm with Task Shade

DIFFRIENT WORK LIGHT II (DX SERIES)

E26 socket compatible with screw-in bulbs up to 60W.

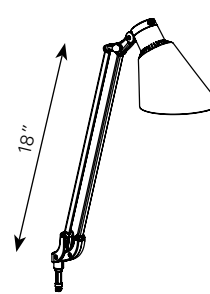

DX1E \$348
Single Arm with Work Shade

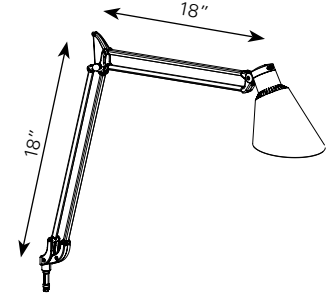

DX2E \$386
Double Arm with Work Shade

2 Mount

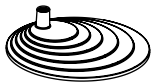

B Add \$108
Diffrient Desktop Base
9" diameter

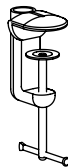

C N/C
Clamp
For grommet or edge mount. Fits surfaces up to 2" thick and grommet holes 2" or more in diameter.

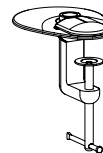

G Add \$12
Clamp with Grommet Cover
For grommet holes 2" – 3.25" in diameter.

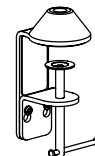

K Add \$18
2-Piece Clamp
Requires minimum 1/4" clearance between desk and wall or panel.



2 Mount, cont.



Panel Mount Add \$30

- PC** Allsteel Concensys
- P2** Allsteel Terrace 2.6 & 3.4, Align
- PH** Haworth Places, Unigroup
- PM** Haworth Premise
- PA** Herman Miller Action Office
- PR** Herman Miller Resolve
- P9** Steelcase 9000
- PB** Teknion Boulevard
- PI** Teknion IE
- PL** Teknion Leverage, Transit

*Not compatible with corner mount applications.
For other panel systems, see your Humanscale representative.*

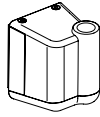

U Add \$30

Universal Panel Mount
Adjusts to fit most panels that use vertical slotted rails for mounting accessories. Not compatible with corner applications.

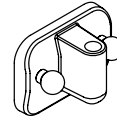

S N/C

Universal Slatwall
Adjusts to fit most standard slatwalls.



W N/C

Wall
Screws into vertical surface.

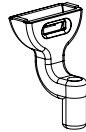

A N/C

Humanscale Access Rail



D N/C

Direct
Screws into horizontal surface.

NM N/C

No Mount

3 Color

S
Silver

B
Black

4 Lamp

DIFFRIENTASK II LIGHT (DA SERIES)

A	18W, 3500K, GU24 base (standard)	N/C
C	13W, 3500K	N/C
D	9W, 3500K	N/C
E	18W, 2700K	N/C

DIFFRIENT WORK LIGHT II (DX SERIES)

1	18W, 3500K, E26 socket (standard)	N/C
2	23W, 3500K	N/C
3	13W, 3500K	N/C
4	9W, 3500K	N/C
6	18W, 2700K	N/C
7	18W, 5500K, Full Spectrum	Add \$24
0	No Bulb	Less \$6

Build Your Diffrient Technology Light Product Code

Diffrient Technology Light

To create the product code for your Diffrient Light, simply choose your preferred style, base features, color, lamp, and accessories and combine the respective codes for each.

Diffrient Technology Light Product Code:

Style	Mount	Color	Lamp	Accessories
1	2	3	4	5
_____	_____	_____	_____	_____

1 Style

DIFFRIENT TECHNOLOGY LIGHT (DTECH SERIES)

E26 socket compatible with screw-in bulbs up to 60W

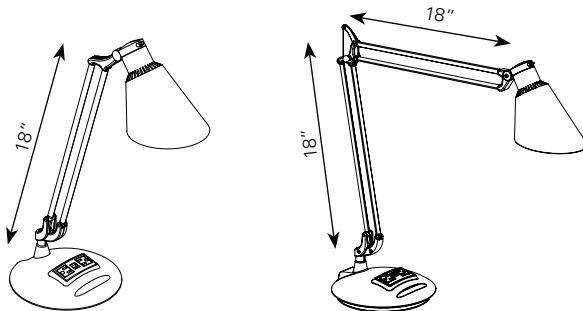

DTECH1E \$515
Single Arm with Work Shade

DTECH2E \$551
Double Arm with Work Shade

DIFFRIENT TECHNOLOGY LIGHT (DTECHT SERIES)

By special order, consult your Humanscale rep.
Compatible with GU24 2-pin compact fluorescent bulbs.

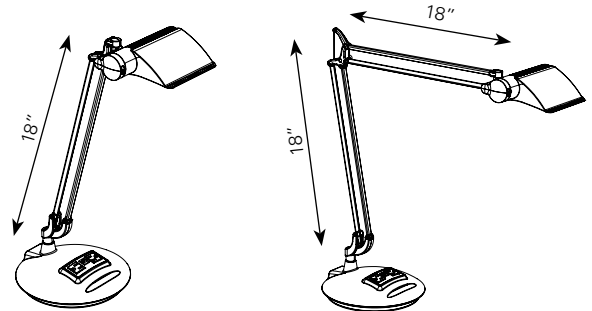

DTECHT1E \$515
Single Arm with Task Shade

DTECHT2E \$551
Double Arm with Task Shade

2 Base Features



P N/C
2 Outlets

T Add \$24
2 Outlets with CAT5/6 Data Port

3 Color

S
Silver

B
Black



4 Lamp

DIFFRIENT TECHNOLOGY LIGHT (DTECH SERIES)

1	18W, 3500K, E26 socket (standard)	N/C
2	23W, 3500K	N/C
3	13W, 3500K	N/C
4	9W, 3500K	N/C
6	18W, 2700K	N/C
7	18W, 5500K, Full Spectrum	Add \$24
0	No Bulb	Less \$6

DIFFRIENT TECHNOLOGY LIGHT (DTECHT SERIES)

A	18W, 3500K, GU24 base (standard)	N/C
C	13W, 3500K	N/C
D	9W, 3500K	N/C
E	18W, 2700K	N/C

5 Accessories

For Base "T" ONLY

—	No accessories	N/C
C3	3' CAT5 User Internet Cord (red)	Add \$6
C10	10' CAT5 Supply Internet Cord (black)	Add \$12
CB	Both 3' User Internet Cord and 10' Supply Internet Cord	Add \$18

Diffrient Light Replacement Parts

(if purchased separately)

TASK LIGHT II AND WORK LIGHT II MOUNTS (DA & DX SERIES)

Diffrient Desktop Base	DLBS (silver), DLBB (black)	\$150
Access Rail	DLAS (silver), DLAB (black)	\$42
Clamp For grommet or edge mount	DLCS (silver), DLCB (black)	\$42
2-Piece Clamp For edge mount	DLKS (silver), DLKB (black)	\$60
Direct	DLDS (silver), DLDB (black)	\$42
Universal Slatwall	DLSS (silver), DLSB (black)	\$42
Wall	DLWS (silver), DLWB (black)	\$42
Universal Panel Mount	DLUS (silver), DLUB (black)	\$72
Panel Mount	DL 1 1 2	\$72

(1): Panel System Code, (2): Color (B or S)

Grommet Cover	DLGC (black)	\$12
----------------------	---------------------	------

For use with Clamp Mount C

TASK AND WORK LIGHT ACCESSORIES (DT & DW SERIES)

Electronic Ballast	DLBALE (gray)	\$151
Magnetic Ballast	DLBALM (black)	No longer available
Lamp 26W, 3500K, 4-Pin Base	DLBULB	\$26

WORK LIGHT II AND TECHNOLOGY LIGHT ACCESSORIES (DX & DTECH SERIES)

Lamp 18W, 3500K, screw-in base	DLCLF1	\$10
Lamp 23W, 3500K, screw-in base	DLCLF2	\$10
Lamp 13W, 3500K, screw-in base	DLCLF3	\$10
Lamp 9W, 3500K, screw-in base	DLCLF4	\$10
Lamp 18W, 2700K, screw-in base	DLCLF6	\$10
Lamp 18W, 5500K, Full spectrum	DLCLF7	\$36

TASK LIGHT II AND TECHNOLOGY LIGHT ACCESSORIES (DA SERIES & DTECHT SERIES)

Lamp 18W, 3500K, GU24 base	DLSLIMA	\$10
Lamp 13W, 3500K, GU24 base	DLSLIMC	\$10
Lamp 9W, 3500K, GU24 base	DLSLIMD	\$10
Lamp 18W, 2700K, GU24 base	DLSLIME	\$10

TECHNOLOGY LIGHT ACCESSORIES (DTECH & DTECHT SERIES)

3' CAT5 User Internet Cord	CAT5CORD3	\$6
10' CAT5 Supply Internet Cord	CAT5CORD10	\$12



Lighting Accessories

Occupancy Sensor Power Strip

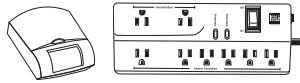

OCCSTRIP

\$288

8-outlet power strip with energy-saving personal occupancy sensor

Benefits of Energy-Efficient Task Lighting

Improve Comfort

Different tasks and different users can require significantly different levels of light, and therefore can't be accommodated by single-source overhead lighting schemes.

Task lighting is essential for ergonomic comfort by supplying the right amount of adjustable illumination for each user and task while reducing eyestrain, headaches, monitor glare, and other symptoms caused by poor office lighting.

Save Energy

When task lights are implemented at each workstation in an office, ambient lighting levels can be reduced. And when lower levels of overhead lighting are combined with energy-efficient task lights, the cost-savings can be significant.

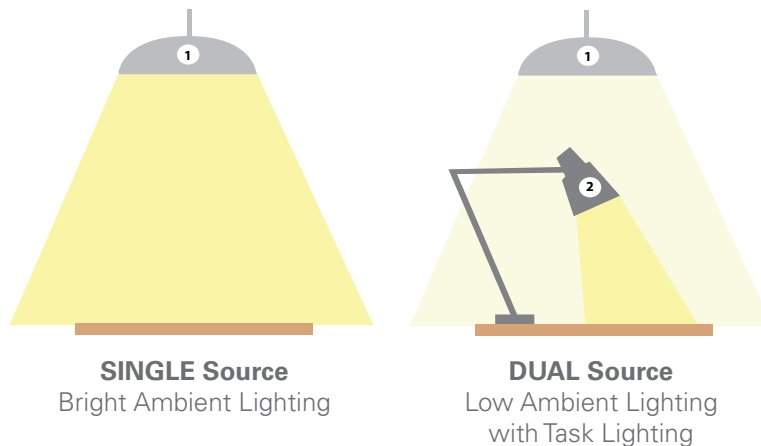

Humanscale and the Environment

RECYCLED MATERIALS			
Product	Recycled Content	Recyclable Content	LEED Recycled Content Post-Consumer +1/2 Pre-Consumer
Diffrient Task and Work Light with Base	90% recycled (63% Post-Consumer, 27% Pre-Consumer)	90% recyclable	77%
Diffrient Technology Light	38% recycled (13% Post-Consumer, 25% Pre-Consumer)	98% recyclable	26%
Element Light, Element 790	81% recycled (55% Post-Consumer, 26% Pre-Consumer)	99% recyclable	68%
Tolomeo Light	77% recycled (40% Post-Consumer, 27% Pre-Consumer)	87% recyclable	52%
Freedom Chair	62% recycled (43% Post-Consumer, 19% Pre-Consumer)	90% recyclable	53%
Freedom Saddle/ Pony Saddle	59% recycled (41% Post-Consumer, 18% Pre-Consumer)	90% recyclable	50%
Liberty Chair	54% recycled (32% Post-Consumer, 22% Pre-Consumer)	93% recyclable	43%
Liberty Side Chair	85% recycled (49% Post-Consumer, 36% Pre-Consumer)	93% recyclable	67%
Cinto chair	26% recycled (15% Post-Consumer, 11% Pre-Consumer)	100% recyclable	21%
Diffrient World Chair	34% recycled (10% Post-Consumer, 24% Pre-Consumer)	97% recyclable	22%
M2 Monitor Arm	52% recycled (46% Post-Consumer, 6% Pre-Consumer)	99% recyclable	49%
M8 Monitor Arm	62% recycled (43% Post-Consumer, 19% Pre-Consumer)	99% recyclable	53%
M7 Monitor Arm	90% recycled (63% Post-Consumer, 27% Pre-Consumer)	100% recyclable	77%
M4 Monitor Arm	67% recycled (47% Post-Consumer, 20% Pre-Consumer)	100% recyclable	57%
Paramount	48% recycled (33% Post-Consumer, 15% Pre-Consumer)	99% recyclable	41%
Access Rail	98% recycled (70% Post-Consumer, 28% Pre-Consumer)	100% recyclable	84%
Keyboard Systems	25% recycled (15% Post-Consumer, 10% Pre-Consumer)	80% recyclable	20%
CPU600, CPU200	51% recycled (34% Post-Consumer, 17% Pre-Consumer)	99% recyclable	43%
CPU555, CPU450, CPU300, CPU Dolly	30% recycled (21% Post-Consumer, 9% Pre-Consumer)	90% recyclable	26%
NeatLinks	50% recycled (50% Post-Consumer, 0% Pre-Consumer)	100% recyclable	50%
L6	30% recycled (23% Post-Consumer, 7% Pre-Consumer)	90% recyclable	27%

Humanscale Terms and Conditions

THE FOLLOWING TERMS & CONDITIONS APPLY TO ALL HUMANSCALE PRODUCTS.

TERMS OF PAYMENT

Upon approved credit, terms of payment are net 30 from date of shipment. Deposits may be required for large or custom orders. The processing of orders and/or shipment of orders placed may be delayed if the deposit is not received with the order or if customer's account is in "Past Due" status.

CREDIT POLICY

All customers of Humanscale must complete a credit application, with current information, which must be signed by an owner or officer. A line of credit may be set by our Credit Department, however the basis for the line of credit may be changed or cancelled at our discretion and advance payment may be required. Any unpaid balance, upon which payments are not made according to the terms governing the sale, will be considered "Past Due" and will increase by a maximum of 2% per month, without forfeit of Humanscale's right to payment.

Any customer who has failed to pay for goods delivered or services rendered in a timely manner shall be liable for all fees, expenses, disbursements, and charges (including all legal costs) incurred by Humanscale in collecting monies owed, as well as interest (at 24% per annum).

PURCHASE ORDERS

Purchase orders must include the following: "Bill To" and "Ship To" information—Company Name (Ship To company may be end user or installation company), Address, Telephone, Fax, Contact Person; End User Company Name; Requested Ship Date; Purchase Order Number; Special Delivery, Shipping and Packing Instructions (if applicable); Proper Discount Off Current List Price, Product Quantities and Full Model Numbers; and Total (List/Net).

ORDER CHANGES & CANCELLATIONS

All changes to or cancellations of orders placed with Humanscale must be in writing and sent to Customer Service. Orders may be changed or cancelled without penalty if Humanscale is notified at least two (2) weeks before the scheduled ship date for standard orders (under 250 units), or at least three (3) weeks before the scheduled ship date for large orders (250 units or more). Order changes or cancellations made less than two (2) weeks before the scheduled ship date for standard orders or less than three (3) weeks before the scheduled ship date for large orders will incur a minimum change/cancellation fee of 10% of net. Irrespective of when notified, changes or cancellations are not binding upon Humanscale until Humanscale issues a written acknowledgment of the change or cancellation. Order changes are defined as the deletion of line items; changes in style, color, quantity or requested ship date; or ship-to address changes. Order changes that result in a quantity reduction may be subject to an additional small order fee or adjustment in pricing. Under no circumstances will changes or cancellations be accepted on any custom fabric, special order or custom product orders.

TAXES

Humanscale list prices do not include sales tax. Customer is responsible to remit all such tax. Humanscale requires a State Resale/Exemption Certification to be on file at its main office. Sales made without said Certificate will be charged the appropriate sales tax.

PRICES

All discounts and list prices are subject to change without notice. Prices are those in effect at the time of order entry. If the requested shipment date is more than 90 days after the order date, Humanscale reserves the right to price said order based on the published list price as of the shipment date.

SMALL ORDER FEE

A 3% small order fee applies to all invoiceable orders of \$1,500 net or less, including billable replacement parts, regardless of product category.

SHIPPING AND DELIVERY

All Humanscale orders are acknowledged with a promise date (scheduled ship date) based on the product with the longest lead time. Large orders may increase standard lead times. Standard shipping charges will be billed to customer. Custom platform orders require 4 to 6 weeks.

Seating orders, unless otherwise specified, will ship 4 to 6 weeks from the date of order. Unless otherwise contractually specified, Diffrient World, Freedom and Liberty chairs will ship with the base and frame disassembled. Chairs can be easily assembled in seconds without use of tools. Blanket-wrapped shipping is available for full truckloads of 200 or more Diffrient World, Freedom or Liberty Task and Conference chairs. Consult your Humanscale representative for blanket-wrapped shipping requirement for Cinto and the Liberty Side chair.

Ship Sets: All products ordered on a single purchase order will be delivered together in a single ship set. To break a ship set, customers must indicate "Ship as Available" on the purchase order. Upon request, customer accounts may be defaulted to ship all orders on an as-available basis.

Shipping Instructions: Humanscale will attempt to accommodate basic shipping instructions, such as "call ahead" or "deliver before 12:00 p.m.," if clearly identified on the purchase order as "Shipping Instructions."

Packing Instructions: Humanscale will attempt to accommodate basic packing instructions for internal delivery of specific items on an order, such as "Deliver to Joe Smith" or "Deliver to cube #218," if clearly identified on the purchase order as "Packing Instructions."

DELIVERY SHORTAGES

Product shortages must be noted at the time of delivery and reported to the carrier for correction. Claims against Humanscale for shortages, errors, etc., must be made in writing and within three (3) days of the date of delivery or customer waives its right to make such a claim.

FREIGHT CLAIMS

Humanscale will file all F.O.B. destination claims. In order to receive credit, customer agrees to cooperate and assist in the procedures set out by the carrier and Humanscale.

EXTERNAL DAMAGE

If the shipping container shows any external damage, customer is instructed to refuse the product at time of delivery. If it is a multiple piece shipment, customer may refuse only the damaged items. Humanscale will not issue full credit for returned product unless customer takes the following action steps:

1. Note damage on the delivery receipt at time of delivery.
2. Refuse product at time of delivery.
3. Contact Humanscale Customer Service within 24 hours of the attempted delivery and advise them of the damage.
4. Enter a chargeable replacement order; credit will be issued after the disposition of damaged product is determined.

CONCEALED DAMAGE/LOSS

If customer determines that there is internal damage not visible at time of delivery, customer will retain all packaging materials and take the following action steps within fifteen (15) calendar days from the date of delivery:

1. Request inspection by calling local freight carrier to report damage.
2. Retain merchandise in the original box.
3. Call your Humanscale Customer Service agent to provide order and product information.
4. Get a copy of the inspection report from carrier.
5. Enter a chargeable replacement order; credit will be issued after the disposition of damaged product is determined.

STORAGE

If a customer is unable to accept a scheduled product delivery, Humanscale, if notified in writing after product assembly and prior to the scheduled ship date, will store the product at customer's expense. Humanscale shall invoice customer for the product and monthly Storage Fees.

Storage Fees will be 1% of the net order value per month or actual storage costs—whichever is greater. Storage Fees are calculated with a one-month minimum and will not be pro-rated. If customer is unable to accept a scheduled product upon delivery, customer shall be responsible for placing the product in storage and bears the risk of loss. However, payment of the balance due is per Humanscale's Terms of Payment.

RETURN AUTHORIZATIONS & REFUSALS

All returned and non-damaged refused orders are subject to a five percent (5%) restocking fee. Seating and special order returns will not be accepted. Customer must request a Return Authorization through the Humanscale Customer Service Department within 45 days of product receipt to return any product. If Humanscale agrees to restock the product, customer must return it freight prepaid to Humanscale, F.O.B., to the original shipping point or as otherwise instructed by Humanscale Customer Service. If product is returned without a Return Authorization, Humanscale will notify customer of the unauthorized return and customer must provide instructions for its disposition within one week thereafter. Failure of customer to respond within one week will result in Humanscale's right to dispose of the product with no credit. Return Authorizations expire sixty (60) days after the date of issue. If the returned product is not in resalable condition, customer will not receive credit for the return. Customer must promptly provide a purchase order or other acceptance of fees/credit reduction as required.

WARRANTY

THE FOLLOWING WARRANTY IS IN LIEU OF ALL OTHER WARRANTIES EXPRESS OR IMPLIED, INCLUDING, BUT NOT LIMITED TO, THE IMPLIED WARRANTY OF MERCHANTABILITY AND FITNESS FOR A PARTICULAR PURPOSE AND ALL OTHER WARRANTIES ARISING FROM COURSE OF DEALING OR USAGE OF TRADE.

Humanscale offers the following warranties on its products:

PRODUCT	WARRANTY
Customer's Own Material (COM, COL)	No Warranty
CFL Light Bulbs	1 Year, Single-Shift Warranty
Switch Mouse	1 Year, 24/7 Warranty
Artemide Tolomeo Light	2 Years, 24/7 Warranty
Diffrient Light	5 Years, 24/7 Warranty
Fabric/Cushions/Arm Pads	5 Years, Single-Shift Warranty
Element Light, Including Light Source	10 Years, 24/7 Warranty
M4, M7 & M8 Monitor Arms with Gas Cylinder Components	10 Years, 24/7 Warranty
All seating and other products detailed in a current Humanscale Price Guide, unless otherwise specified	15 Years, 24/7 Warranty
All other products NOT detailed in a current Humanscale Price Guide	Varies; consult your Humanscale representative for details

This Warranty is applicable to the initial purchaser only and is non-transferable. If products are procured through authorized Humanscale Dealerships, the end-user customer must be registered with Humanscale for the warranty to be in effect. Humanscale warrants that, at the time of customer's receipt, the product will be in good working order and will be free from defects in material and workmanship. This Warranty does not apply to normal wear and tear or damage caused by accident, neglect, misuse or improper installation or operation. Humanscale will not be responsible for damage due to service, maintenance, modifications or tampering by anyone other than a Humanscale authorized representative. In the event a product is defective and Humanscale receives written notice of the defect within the Warranty period, Humanscale, at its option, will either repair or replace the defective product. This Warranty does not cover damage caused by a carrier or transportation of the product from one location to another, or alterations made by owner.

LIMITATION OF LIABILITY

Purchaser's remedies set forth herein are exclusive and the liability of Humanscale with respect to the breach of this agreement or any contract entered into between the parties pursuant hereto shall not exceed the price of the product or part on which such liability is based. In no event will Humanscale be liable to purchasers for any special, collateral, incidental or consequential damages however caused, whether by Humanscale's negligence or otherwise.

The remedies provided above are the purchaser's sole remedies for any failure of Humanscale to comply with its obligations regarding the workmanship of its products. Correction of any nonconformity in the manner and for the period of time provided shall constitute complete fulfillment of all liabilities of Humanscale, with respect to or arising out of the product furnished hereunder.



Lighting Pricing and Specification Guide

Price Guide - Canada Prices effective November 2010 



Customer Service

10 Inverness Drive East
Suite 100
Englewood, CO 80112
800 400 0625
303 858 9912
303 858 9916 fax
info@humanscale.com

U.S. Headquarters

11 East 26th Street
8th Floor
New York, NY 10010
212 725 4749
212 725 7545 fax

International Headquarters

13 Northburgh Street
London
EC1V 0JP
United Kingdom
+44 207 566 7990
+44 207 566 7991 fax
info@humanscale.co.uk

www.humanscale.com

HSITGPGC110